

SCALE-1/300

道路位置標識
SCALE=1/10

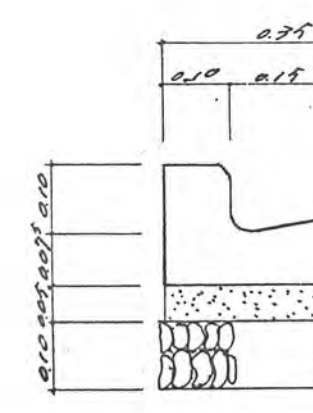

51年4月3日第2号
幅員4.0m延長11.98m
201

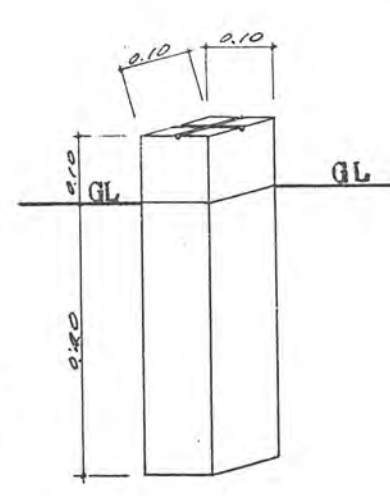
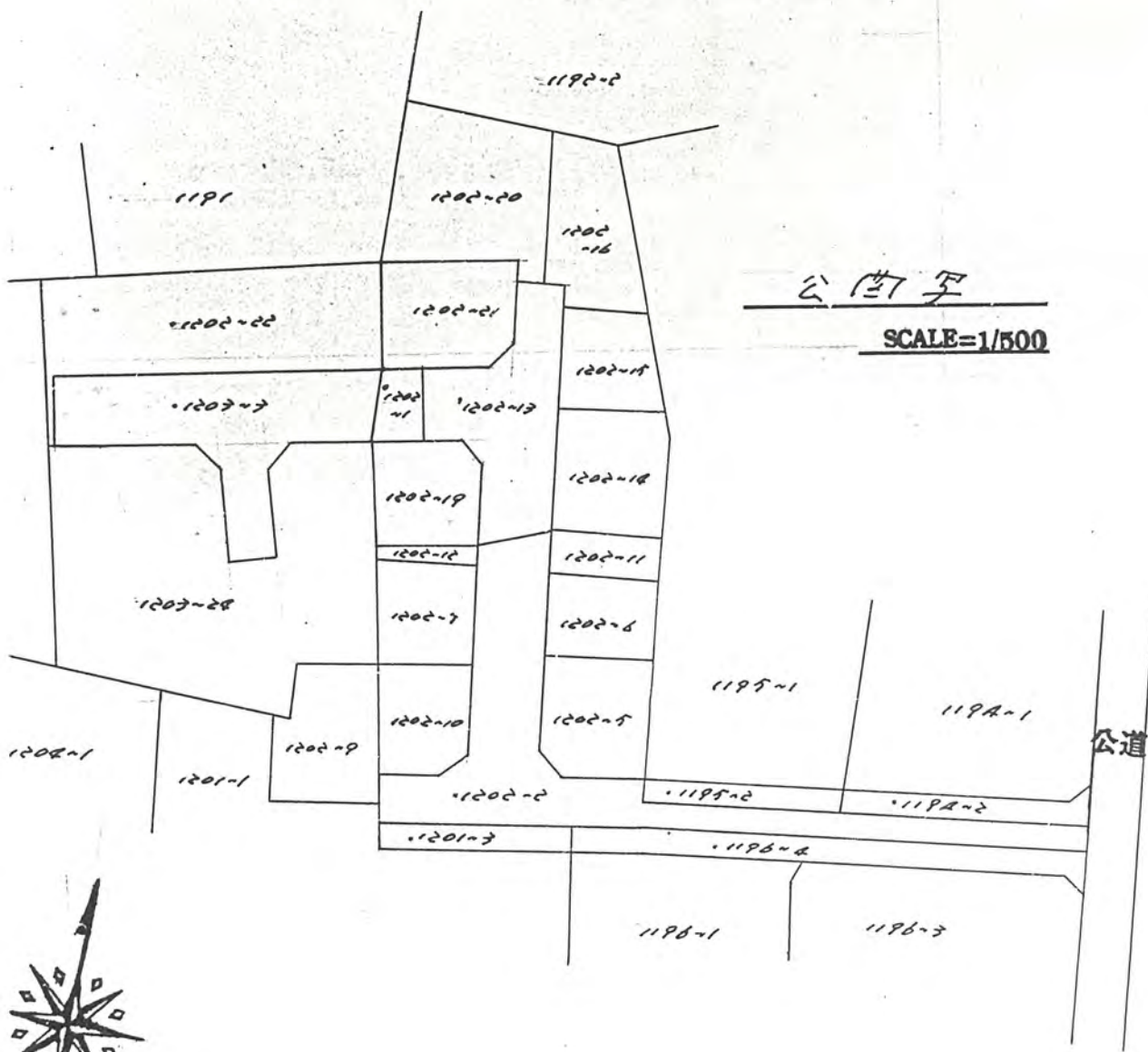

公街字

SCALE=1/500

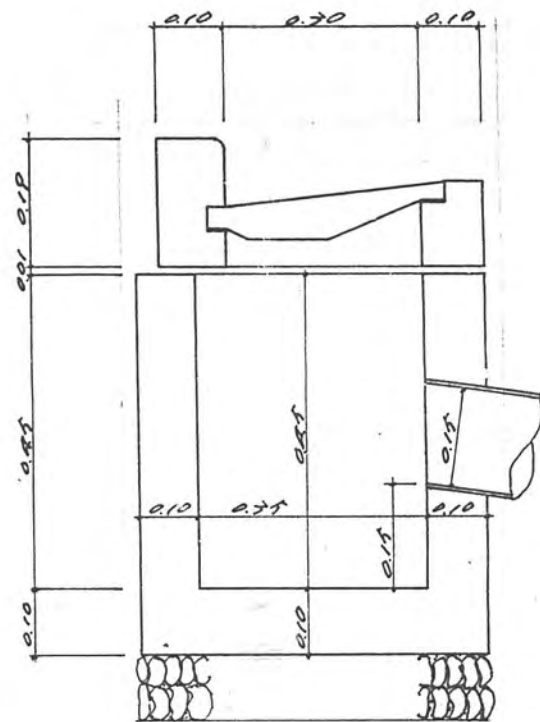

集水溝構造圖

SCALE=1/10

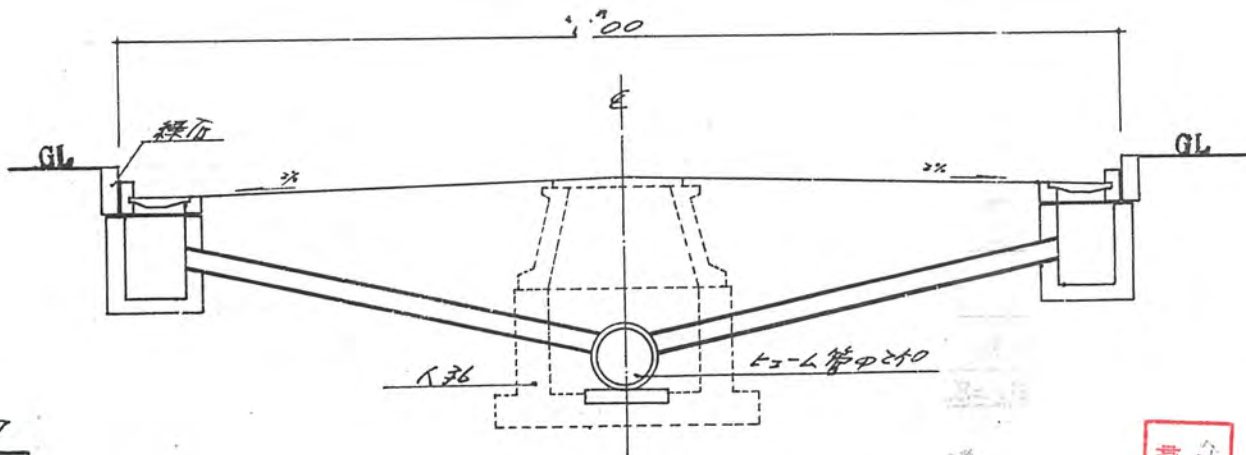
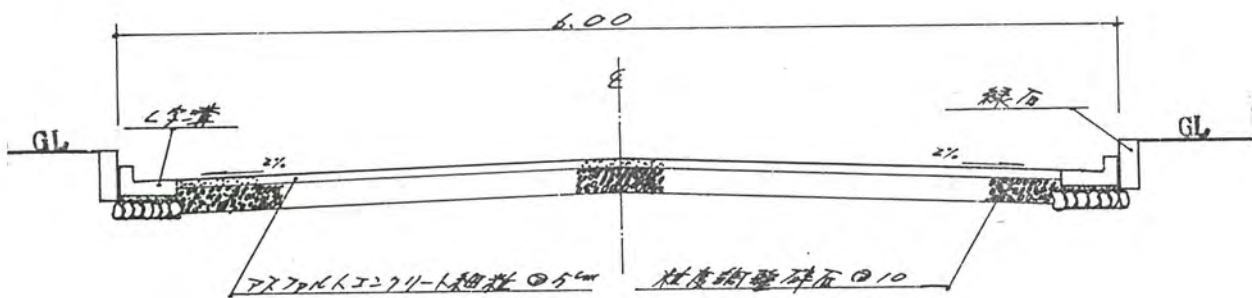
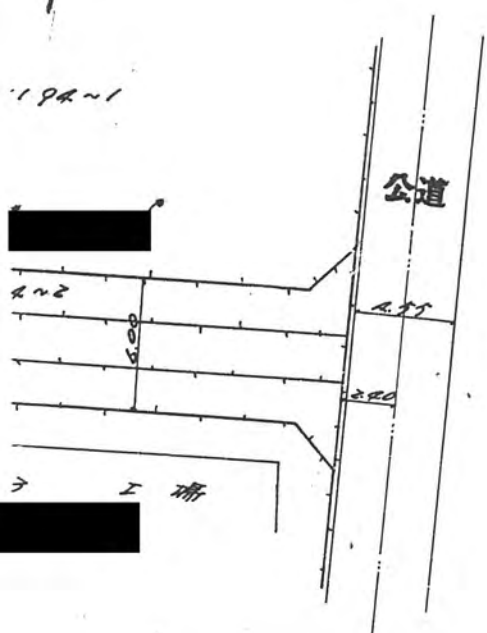

道路構造圖

SCALE=1/40

L字溝構造圖

SCALE=1/10

51年4月3日第2号
幅員40m 延長30.4m
4002